



---

## Wire-thread inserts

Heavy-duty threads for series or repair

# The center of excellence for high-performance fastening technology

---

KVT-Fastening is an expert for high-quality fastening applications and offers engineering solutions based on the wide product portfolio of the leading manufacturers in the market.



Mechanical engineering | Automotive | Electrical engineering | Energy | Precision engineering | Fluid power | Transportation | Off-shore and Marine | Medical equipment  
Aviation and aerospace | Construction industry | Watch manufacturing industry

[www.kvt-fastening.com](http://www.kvt-fastening.com)



High-performance solutions from KVT-Fastening are found wherever absolutely safe and secure connections are essential. These small but extremely resilient components play key roles where it matters most – whether in the electronics and energy sector, the automotive and transportation industries, aviation and aerospace, engineering and construction, precision engineering, or medical equipment.

KVT-Fastening does not just supply standard products and individual components, but also provides close and active customer support in the search for ideal solutions, particularly when specific requirements must be fulfilled. This portfolio is complemented by a range of innovative tools and

machines as well as, if needed, the integration into automated serial production workflows.

Ever since 1927, KVT-Fastening has stood for experience, solution-driven know-how, unique expertise in development and consultancy as well as the ultimate in reliability. Since December 2012, KVT-Fastening is a member of the Bossard Group. Bossard is a leading provider of intelligent solutions for industrial fastening technology. The range includes global sales, technical consulting (engineering) and logistics of fastening technology components and bolts. Customers benefit from the extension of competencies in industrial fastening technology and from an optimally enhanced product or service portfolio.



## The perfect solution for every application and type of stress

Wire-thread inserts make it possible to create high-strength threads with optimum power transmission from the screw to the base thread. They are outstandingly suitable for thread reinforcement in materials of limited shear strength, such as aluminum or magnesium and they have therefore become indispensable in machinery construction. These wire-thread inserts are also excellently suited for repair and maintenance purposes. The threaded inserts without tang have a bi-directional installation notch making them extremely safe as there is no danger from tangs remaining in the component.

### **FILTEC®+ wire-thread inserts for standard applications**

FILTEC®+ wire-thread inserts are the optimum solution in the field of standard applications. The range of use extends from connections repeatedly disconnected to the reconstruction of damaged threads.

This threaded insert simplifies installation considerably for the user. Thanks to its optimised conception the FILTEC®+ is very easy to turn in and install.

### **Lockfil®+ wire-thread inserts for oscillating stresses or vibration**

LOCKFIL®+ wire-thread inserts have in addition one or more polygonal threads which exert pressure on the flanks of the screw installed.

These threaded inserts therefore are especially suitable for applications which are subject to oscillating stresses or vibration. This means that additional securing screws can be dispensed with.

### **KATO® wire-thread inserts for the high-strength field**

In the field of high-strength wire-thread inserts, KATO® threaded inserts are suitable for heavy-duty threads, connections repeatedly disconnected or the reconstruction of damaged threads. KATO® wire-thread inserts without tang are convincing with their efficient installation without breaking tangs.



# Contents

---

## Wire-thread inserts with tang

<b>FILTEC®+   LOCKFIL®+</b> Technical information, installation	6 – 7
--	-------

<b>FILTEC®+</b> Free running	8 – 9
---------------------------------	-------

<b>LOCKFIL®+</b> Self-locking with polygonal threads	10 – 11
---	---------

<b>FILTEC®+   LOCKFIL®+</b> Strip feed threaded inserts	12
--	----

<b>FILTEC®+   LOCKFIL®+   KATO®</b> Taps	14 – 15
---	---------

<b>FILTEC®+   LOCKFIL®+</b> Inserting tools accessories	16 – 17
--	---------

<b>FILTEC®+</b> Repair boxes and selection boxes	18 – 19
---	---------

## Wire-thread inserts without tang

<b>KATO®</b> Installation	20
------------------------------	----

<b>KATO®</b> Standard and self-locking design	21
--	----

<b>KATO®</b> Tools	22
-----------------------	----

All dimensions are specified in mm.

# Technical information

The wire-thread inserts FILTEC®+ and LOCKFIL®+ of the standard material X5 Cr Ni 18-10 (A2) are corrosion-resistant with respect to normal environmental conditions. For connections subject to high levels of thermal and corrosive stress corresponding materials are available on request.

The elastic wire-thread inserts lead to better distribution of loads and tension between screw and base thread. This improves the transmission of force of the screwed connection both for static as well as for dynamic applications.

The diameter of the threaded inserts before installation is greater than that of the base thread. This results in a self-locking effect of the insert. Material can be saved and weight reduced without any problem through using the high-strength threaded inserts, since there are less connecting points and at the same time, space is saved.

The values of wall thicknesses were established for the application in cast or rolled aluminum alloys and a thread length of  $1.5 \times d$  and represent guide values only.

d	= Nominal diameter
B	= Flank diameter
P1 min.	= $0.375 \times B$
P2 min.	= $1.75 \times B$

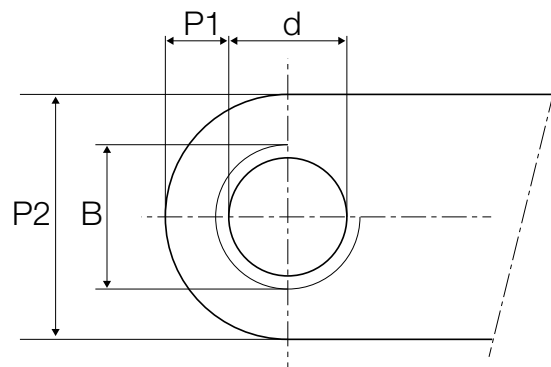

# Installation wire-thread inserts

With tang

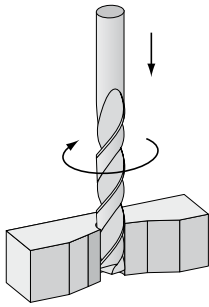

## 1. Drill the hole

Use an ordinary twist drill, watch the diameter! Do not counter-sink if it can be avoided.

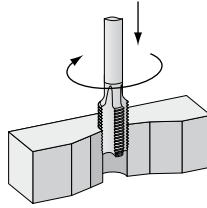

## 2. Cut the thread

Only cut the mounting thread with the correct tap for the thread size selected.

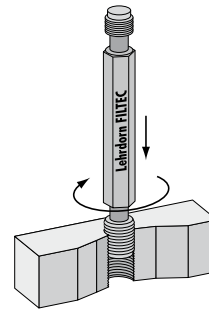

## 3. Check the tapped thread (optional)

If the mounting thread has to be checked, there are gauges available.

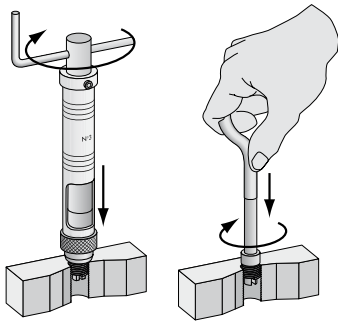

## 4. Installation

The threaded insert can be screwed directly into the base thread. The end of the wire should be screwed at least 1/4-turn under the material surface.

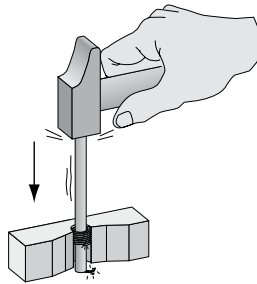

## 5. Tang

To make a through hole, the tang is broken off using the tang remover. In threads in blind holes, the tang may be left in place provided the maximum screw-in depth is taken into account.

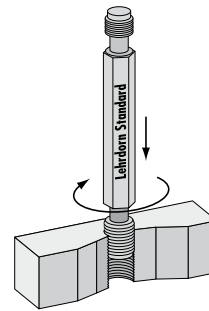

## 6. Check the thread (optional)

After removing the threaded insert (optional) renewed check.

# Wire-thread inserts

With tang



## Free running

### Material

Stainless steel 1.4301

Further designs on request

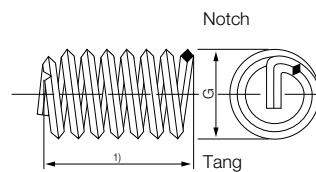

**Ordering data example:** M6x100 AC 6 +  
 Nominal-Ø + pitch  
 Stainless steel  
 Nominal length

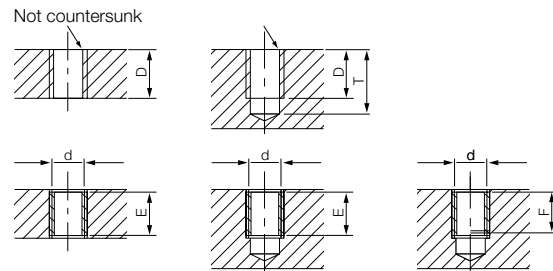

d Nominal-Ø and pitch	D Nominal thread length		Core drill hole	E Usable length Threaded insert	F Usable length, tang not removed	G Diameter removed		T Drilled hole depth min.
	mm	xd				min.	max.	
M2.5 x 0.45	2.50	1.0 d	2.6	2.1	1.8	3.15	3.30	5.10
	3.75	1.5 d		3.3	3.1			6.35
	5.00	2.0 d		4.6	4.3			7.60
M3 x 0.50	3.00	1.0 d	3.2	2.5	2.3	3.70	3.90	5.80
	4.50	1.5 d		4.0	3.8			7.30
	6.00	2.0 d		5.5	5.3			8.80
	7.50	2.5 d		7.0	6.8			10.30
M4 x 0.70	4.00	1.0 d	4.2	3.3	3.0	5.00	5.15	7.80
	6.00	1.5 d		5.3	5.0			9.80
	8.00	2.0 d		7.3	7.0			11.80
	10.00	2.5 d		9.3	9.0			13.80
M5 x 0.80	5.00	1.0 d	5.2	4.2	3.8	6.10	6.30	9.20
	7.50	1.5 d		6.7	6.3			11.70
	10.00	2.0 d		9.2	8.8			14.20
	12.50	2.5 d		11.7	11.3			16.70
M6 x 1.00	6.00	1.0 d	6.3	5.0	4.5	7.40	7.65	11.10
	9.00	1.5 d		8.0	7.5			14.10
	12.00	2.0 d		11.0	10.5			17.10
	15.00	2.5 d		14.0	13.5			20.10
M8 x 1.25	8.00	1.0 d	8.40	6.8	6.2	9.70	9.90	14.20
	12.00	1.5 d		10.8	10.2			18.20
	16.00	2.0 d		14.8	14.2			22.20
	20.00	2.5 d		18.8	18.2			26.20
M10 x 1.50	10.00	1.0 d	10.50	8.5	7.8	12.05	12.35	17.30
	15.00	1.5 d		13.5	12.8			22.30
	20.00	2.0 d		18.5	17.8			27.30
	25.00	2.5 d		23.5	22.8			32.30

<sup>1)</sup> Before installation about 1/3 shorter than nominal length D



# Wire-thread inserts

With tang



## Free running

See page 8

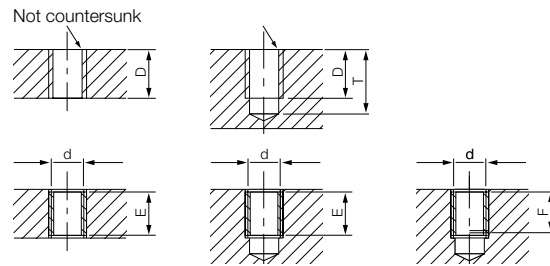
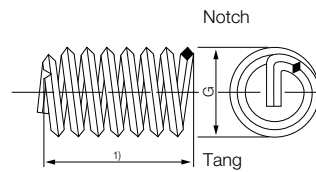

d Nominal-Ø and pitch	D Nominal thread length		Core drill hole	E Usable length Threaded insert	F Usable length, tang not removed	G Diameter removed		T Drilled hole depth min.
	mm	x d				min.	max.	
M12 x 1.75	12.00	1.0 d	12.50	10.3	9.4	14.35	14.60	20.30
	18.00	1.5 d		16.3	15.4			26.30
	24.00	2.0 d		22.3	21.4			32.30
	30.00	2.5 d		28.3	27.4			38.30
M14 x 2.00	14.00	1.0 d	14.50	12.0	11.1	16.80	17.15	23.30
	21.00	1.5 d		19.0	18.1			30.30
	28.00	2.0 d		26.0	25.1			37.30
	35.00	2.5 d		33.0	32.1			44.30
M16 x 2.00	16.00	1.0 d	16.50	14.0	13.1	18.80	19.10	25.30
	24.00	1.5 d		22.0	21.1			33.30
	32.00	2.0 d		30.0	29.1			41.30
	40.00	2.5 d		38.0	37.1			49.30
M18 x 2.50	18.00	1.0 d	18.75	15.5	14.3	21.35	21.70	29.20
	27.00	1.5 d		24.5	23.3			38.20
	36.00	2.0 d		33.5	32.3			47.20
	45.00	2.5 d		42.5	41.3			56.20
M20 x 2.50	20.00	1.0 d	20.75	17.5	16.3	23.35	23.75	31.20
	30.00	1.5 d		27.5	26.3			41.20
	40.00	2.0 d		37.5	36.3			51.20
	50.00	2.5 d		47.5	46.3			61.20

<sup>1)</sup> Before installation about 1/3 shorter than nominal length D

# Wire-thread inserts

With tang



## Self-locking with polygonal threads

### Material

Stainless steel 1.4301

Coloured red

Further designs on request

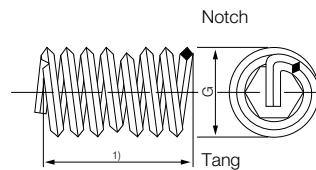

**Ordering data example:** SL M6x100 AC 6 +  
 Self-locking  
 Nominal-Ø + pitch  
 Stainless steel  
 Nominal length

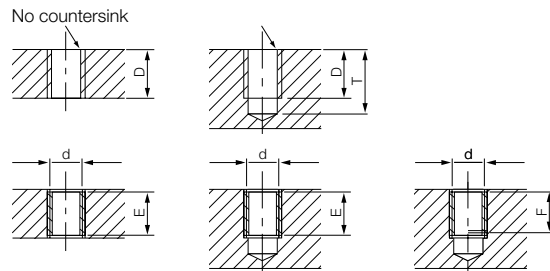

d Nominal-Ø and pitch	D Nominal thread length		Core drill hole	E Usable length Threaded insert	F Usable length, tang not removed	G Diameter removed		T Drilled hole depth min.
	mm	xd				min.	max.	
M3 x 0.50	3.00	1.0 d	3.20	2.5	2.3	3.80	4.00	5.80
	4.50	1.5 d		4.0	3.8			7.30
	6.00	2.0 d		5.5	5.3			8.80
	7.50	2.5 d		7.0	6.8			10.30
M4 x 0.70	4.00	1.0 d	4.20	3.3	3.0	5.00	5.15	7.80
	6.00	1.5 d		5.3	5.0			9.80
	8.00	2.0 d		7.3	7.0			11.80
	10.00	2.5 d		9.3	9.0			13.80
M5 x 0.80	5.00	1.0 d	5.20	4.2	3.8	6.10	6.30	9.20
	7.50	1.5 d		6.7	6.3			11.70
	10.00	2.0 d		9.2	8.8			14.20
	12.50	2.5 d		11.7	11.3			16.70
M6 x 1.00	6.00	1.0 d	6.30	5.0	4.5	7.40	7.65	11.10
	9.00	1.5 d		8.0	7.5			14.10
	12.00	2.0 d		11.0	10.5			17.10
	15.00	2.5 d		14.0	13.5			20.10
M8 x 1.25	8.00	1.0 d	8.40	6.8	6.2	9.70	9.90	14.20
	12.00	1.5 d		10.8	10.2			18.20
	16.00	2.0 d		14.8	14.2			22.20
	20.00	2.5 d		18.8	18.2			26.20
M10 x 1.50	10.00	1.0 d	10.50	8.5	7.8	12.05	12.35	17.30
	15.00	1.5 d		13.5	12.8			22.30
	20.00	2.0 d		18.5	17.8			27.30
	25.00	2.5 d		23.5	22.8			32.30

<sup>1)</sup> Before installation about 1/3 shorter than nominal length D

# Wire-thread inserts

With tang



## Self-locking with polygonal threads

See page 8

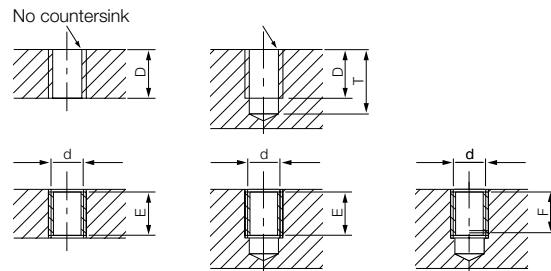
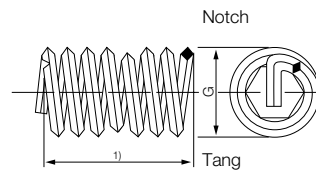

d Nominal-Ø and pitch	D Nominal thread length		Core drill hole	E Usable length Threaded insert	F Usable length, tang not removed	G Diameter removed		T Drilled hole depth min.
	mm	xd				min.	max.	
M12 x 1.75	12.00	1.0 d	12.50	10.3	9.4	14.35	14.60	20.30
	18.00	1.5 d		16.3	15.4			26.30
	24.00	2.0 d		22.3	21.4			32.30
	30.00	2.5 d		28.3	27.4			38.30
M16 x 2.00	16.00	1.0 d	16.50	14.0	13.1	18.80	19.10	25.30
	24.00	1.5 d		22.0	21.1			33.30
	32.00	2.0 d		30.0	29.1			41.30
	40.00	2.5 d		38.0	37.1			49.30
M20 x 2.50	20.00	1.0 d	20.75	17.5	16.3	23.35	23.75	31.20
	30.00	1.5 d		27.5	26.3			41.20
	40.00	2.0 d		37.5	36.3			51.20
	50.00	2.5 d		47.5	46.3			61.20

<sup>1)</sup> Before installation about 1/3 shorter than nominal length D





# Accessories

## Taps AE / EB – SE

### Finishing tap with run-out AE

#### Straight-grooved, with lead taper

The straight-grooved one cut hand-tap is best suited for cutting threads in metal panels and thin work pieces smaller than 1.5 x thread diameter.

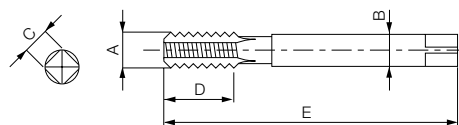

### 2-part hand-tap set EB – SE

#### Undersized tap (EB) and finishing tap without run-out (SE)

The 2-piece hand-tap set is suitable for cutting threads in metal panels and thin work pieces deeper than 1.5 x thread diameter.



AE



EB



SE

d Nominal-Ø and pitch	A	B	C	D	E
M2.5 x 0.45	3.11	3.15	2.50	13	48
M3 x 0.50	3.67	4.00	3.15	16	53
M4 x 0.70	4.94	5.00	4.00	15	58
M5 x 0.80	6.07	6.30	5.00	17	66
M6 x 1.00	7.34	8.00	6.30	20	72
M8 x 1.25	9.67	10.00	8.00	22	80
M10 x 1.50	12.01	9.00	7.10	26	89
M12 x 1.75	14.33	11.20	9.00	27	95
M14 x 2.00	16.66	12.50	10.00	29	102
M16 x 2.00	18.66	14.00	11.20	34	112

### Range of use for AE / EB – SE taps

Tap	Through hole	Blind hole	Manual tapping	Machine tapping	Strength: R < 700 N/mm <sup>2</sup>	Strength: R > 700 N/mm <sup>2</sup>	Pitch < 200	Pitch > 200
AE	■	■	■	■	■	□	■	□
EB+SE	■	■	■	■	■	■	■	■

■ very good   ■ good   □ unsuitable

# Accessories

## Taps GUN / GH

High-performance taps for machine tapping

Spiral-grooved, with first cut GH

Straight-grooved, with first cut GUN

The obliquely-grooved high-performance tap cuts an accurately-sized thread in one cut. For through holes, the straight-grooved GUN tap should be used. The chips are removed from the hole in the advance direction. For blind holes, the spiral-grooved tap is used, as the chips are removed from the hole drilled in the reverse direction.

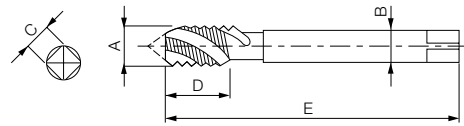

GUN



GH

d Nominal-Ø and pitch	A	B	C	D	E
M2 x 0.45	3.11	3.15	2.50	13	48
M3 x 0.50	3.67	4.00	3.15	16	53
M4 x 0.70	4.94	5.00	4.00	15	58
M5 x 0.80	6.07	6.30	5.00	17	66
M6 x 1.00	7.34	8.00	6.30	20	72
M8 x 1.25	9.67	10.00	8.00	22	80
M10 x 1.50	12.01	9.00	7.10	26	89
M12 x 1.75	14.33	11.20	9.00	27	95
M14 x 2.00	16.66	12.50	10.00	29	102
M16 x 2.00	18.66	14.00	11.20	34	112
M18 x 2.50	21.31	16.00	12.50	35	118
M20 x 2.50	23.31	16.00	12.50	35	118

Up to size M6 with ISO tip

### Range of use fo GUN / GH taps

Tap	Through hole	Blind hole	Manual tapping	Machine tapping	Strength: R < 700 N/mm <sup>2</sup>	Strength: R > 700 N/mm <sup>2</sup>	Pitch < 200	Pitch > 200
GH	☐	■	■	■	■	■	■	☐
GUN	■	☐	■	■	■	■	■	☐

■ very good   ■ good   ☐ unsuitable

# Accessories

## Inserting tools for electric or pneumatic screwdrivers for FILTEC®+

FILTEC®+ with its optimised conception can be installed with usual electric screwdrivers as easily as a screw. The setting tool with necked nose previously required is no longer necessary, but can also be used for FILTEC®+.



Further designs on request

Nominal-Ø and pitch
M3 x 0.50
M4 x 0.70
M5 x 0.80
M6 x 1.00
M8 x 1.25
M10 x 1.50
M12 x 1.75
M14 x 2.00
M16 x 2.00
M20 x 2.50

## Manual inserting tools for FILTEC®+ and LOCKFIL®+

Thanks to optimised conception and these setting tools, FILTEC®+ and LOCKFIL®+ threaded inserts can be turned in as easily as a screw. The setting tool with necked nose is no longer necessary, but can also be used for FILTEC®+ and LOCKFIL®+.

Further designs on request

### 1. Installation tool No. 1 for thread ≤ M3

No.	Nominal-Ø and pitch
1	M2 x 0.40
	M2.5 x 0.45
	M3 x 0.50

### 2. Setting spindle No. 4 – 17 for threads > M4

No.	Nominal-Ø and pitch
4	M4 x 0.70
6	M5 x 0.80
7	M6 x 1.00
9	M8 x 1.25
11	M10 x 1.50
12	M12 x 1.75
15	M16 x 2.00
17	M20 x 2.50





# Accessories

## Break-off tools

The tang remover is an indispensable accessory to permit the tang to be removed cleanly and to guarantee the screw can be introduced reliably and without problem.

The installation tool must not be used for breaking off the tang.

Metric	Tang remover FILTEC®+ No.	Tang remover LOCKFIL®+ No.
M2 x 0.40	1	-
M2.5 x 0.45	1	1
M3 x 0.50	3	2
M4 x 0.70	4	3
M5 x 0.80	6	5
M6 x 1.00	7	6
M8 x 1.25	9	8
M10 x 1.50	11	10
M12 x 1.75	12	12
M16 x 2.00	15	15
M20 x 2.50	16	16

# Repair boxes

Type M3 x 0.50

Type M4 x 0.70

Type M5 x 0.80

Type M6 x 1.00

Type M8 x 1.25

Type M10 x 1.50

Type M12 x 1.75

**Repair box complete, containing:**

- 1 AE tap
- 1 setting tool for the selected diameter<sup>1)</sup>
- 10 threaded inserts of length 1.5 d (M3 – M10)
- 5 threaded inserts of length 1.5 d (M12)
- 1 tang remover (up to M12)



Type M16 x 2.00

Type M20 x 2.50

**Repair box complete, containing:**

- 1 AE tap
- 1 setting tool for the selected diameter<sup>1)</sup>
- 5 threaded inserts of length 1.5 d

Each repair box is designed for a **single diameter and pitch**.

Further designs on request

<sup>1)</sup> Setting tools see page 16

# Selection boxes

## Type No. 10

The selection box contains a complete set of tools and inserts for several diameters.

### Selection box complete, containing:

- 1 installation tool for **each diameter**
- 1 AE tap for **each diameter**
- 1 tang remover for **each diameter**
- 10 of each FILTEC®+ threaded inserts



Nominal-Ø and pitch	Order description
M4 x 0.70	M4 x 70 AC 6
M5 x 0.80	M5 x 80 AC 7.5
M6 x 1.00	M6 x 100 AC 9
M8 x 1.25	M8 x 125 AC 12
M10 x 1.50	M10 x 150 AC 15
M12 x 1.75	M12 x 175 AC 12

# Installation wire-thread inserts

Without tang

---

## Installation principle for KATO® wire-thread inserts

1. Drill the hole
2. Cut the thread
3. Check the tapped thread
4. Install the threaded insert
5. Final check

### View from below of insert installation

The spring hook in the installation tool engages in the driver groove to install the threaded insert without tang.

The tapered ends of the insert allow it to be screwed into the prepared thread without difficulty.

### View of the installation tool releasing from the insert

On reversing direction of rotation, the driver hook disengages and slides back into the installation tool.

Driver groove



Insert



# Wire-thread inserts

Without tang



## Standard

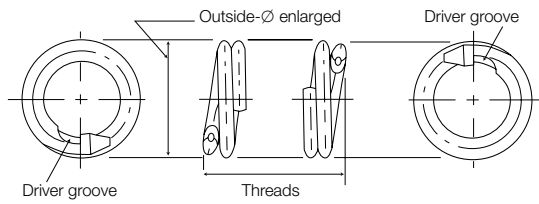

## Self-locking version

Coloured red

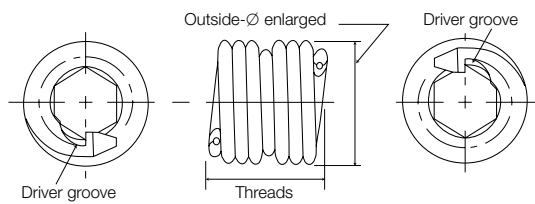

**Ordering data example:** **2TNM** oder **2TLM** **M5 x 0.8** - **10**

Standard

Self-locking

Nominal-Ø + pitch

Nominal thread length 2D

For magazined inserts on rolls, please add "SF" to the order designation.

Nominal-Ø and pitch	Insert type		Nominal thread length <sup>1)</sup>			External-Ø increased		Initial hole-Ø	
	Standard	Self-locking	Length of the insert (xD)			Min.	Max.	Aluminium	Steel/Mg
			1D	1.5D	2D				
<b>M2.5 x 0.45</b>	2TNM	2TLM	2.5	3.8	5	3.20	3.35	2.55	2.65
<b>M3 x 0.5</b>	2TNM	2TLM	3.0	4.5	6	3.80	3.99	3.15	3.20
<b>M4 x 0.7</b>	2TNM	2TLM	4.0	6.0	8	5.05	5.28	4.20	4.25
<b>M5 x 0.8</b>	2TNM	2TLM	5.0	7.5	10	6.20	6.50	5.20	5.30
<b>M6 x 1.0</b>	2TNM	2TLM	6.0	9.0	12	7.40	7.78	6.25	6.30
<b>M8 x 1.25</b>	2TNM	2TLM	8.0	12.0	16	9.80	10.18	8.30	8.40
<b>M10 x 1.5</b>	2TNM	2TLM	10.0	15.0	20	11.95	12.41	10.50	10.50
<b>M12 x 1.75</b>	2TNM	2TLM	12.0	18.0	24	14.30	14.80	12.50	12.50

<sup>1)</sup> Nominal thread length is calculated and cannot be measured when not installed.

# Tools

## Hand tool

### For installing

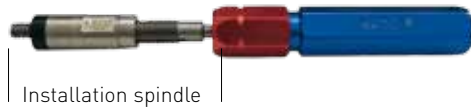

Installation spindle

### Design of the installation spindle

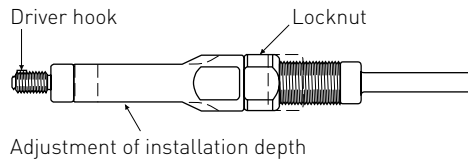

### For removal



Removal spindle

## Blade tips

### Installation

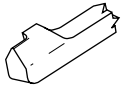

### Removal

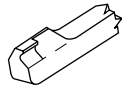

Taps for FILTEC<sup>®</sup>+ and LOCKFIL<sup>®</sup>+ see page 14 – 15, they can also be used for KATO<sup>®</sup>

Further tools available on request

## Hand installation

Nominal-Ø	Installation tool			Removal tool		
	Standard	Self-locking	Spare pawl for installation tool	Standard	Self-locking	Spare pawl for removal tool
<b>M2.5</b>	2CT10-M2.5F	2CT10-M2.5L	2CT20-M2.5	2CT30-M2.5F	2CT30-M2.5L	2CT40-M2.5
<b>M3</b>	2CT10-M3F	2CT10-M3L	2CT20-M3	2CT30-M3F	2CT30-M3L	2CT40-M3
<b>M4</b>	2CT10-M4F	2CT10-M4L	2CT20-M4	2CT30-M4F	2CT30-M4L	2CT40-M4
<b>M5</b>	2CT10-M5F	2CT10-M5L	2CT20-M5	2CT30-M5F	2CT30-M5L	2CT40-M5
<b>M6</b>	2CT10-M6F	2CT10-M6L	2CT20-M6	2CT30-M6F	2CT30-M6L	2CT40-M6
<b>M8</b>	2CT10-M8F	2CT10-M8L	2CT20-M8	2CT30-M8F	2CT30-M8L	2CT40-M8
<b>M10</b>	2CT10-M10F	2CT10-M10L	2CT20-M10	2CT30-M10F	2CT30-M10L	2CT40-M10
<b>M12</b>	2CT10-M12F	2CT10-M12L	2CT20-M12	2CT30-M12F	2CT30-M12L	2CT40-M12

# KVT-Fastening – Fastening technology



Blind rivet nuts



Blind rivet technology



Thread inserts



Self-clinching fasteners



Stud welding systems<sup>1)</sup>



Lock nuts



Bonding fasteners



Access solutions

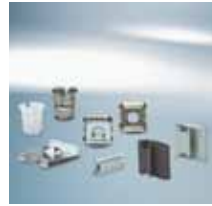

Quick fastening elements and clips



Quick release pins and spring plungers



Adhesives and sealants<sup>1)</sup>



Construction fasteners<sup>2)</sup>



Special processes<sup>2)</sup>



Plugs



Pressure intensifiers<sup>3)</sup>



Installation technology



Quick connectors<sup>4)</sup>

## Fastening, sealing and flow control solutions for complex applications

The extensive KVT-Fastening portfolio offers optimal solutions for your most challenging applications. The products included in this catalog represent only a selection from our entire product portfolio. Upon request, we will be pleased to provide additional information or an individual consultation to you.

## Intelligent logistic systems

Bossard SmartBin and SmartLabel are intelligent logistics systems which monitor stock with total reliability and ensure stock replenishment automatically. An online system transmits the data to the Bossard server, and this – if necessary – triggers an order. These systems ensure quick and easy availability of C-parts while production is running.



Logistic systems

## Competent analysis for efficient solutions

KVT-Fastening's highly qualified experts analyze the given task at hand. Based on this sound understanding of the project, they then develop ideal solutions that are economical, efficient, and safe.



Solutioneering

For more information about our range of products and order at our E-shop, please visit [www.kvt-fastening.com](http://www.kvt-fastening.com)

<sup>1)</sup> Not available in Germany. <sup>2)</sup> Only available in Switzerland. <sup>3)</sup> Not available in Switzerland. <sup>4)</sup> Not available in Austria.

---

**KVT-Fastening**  
**Branch of Bossard Ltd**  
Dietikon/Zürich | Switzerland  
Tel: +41 44 743 33 33  
info-CH@kvt-fastening.com  
www.kvt-fastening.ch

**KVT-Fastening GmbH**  
Illerrieden | Germany  
Tel: +49 7306 782-0  
info-DE@kvt-fastening.com  
www.kvt-fastening.de

**KVT-Fastening GmbH**  
Linz/Pichling | Austria  
Tel: +43 732 25 77 00  
info-AT@kvt-fastening.com  
www.kvt-fastening.at

**KVT-Fastening Sp. z o.o.**  
Radom | Poland  
Tel: +48 58 762 17 80  
info-PL@kvt-fastening.com  
www.kvt-fastening.pl

**KVT-Fastening S.R.L.**  
București | Romania  
Tel: +40 37 1381155  
info-RO@kvt-fastening.com  
www.kvt-fastening.ro

**KVT-Fastening spol. s.r.o.**  
Bratislava | Slovakia  
Tel: +421 9 11102510  
info-SK@kvt-fastening.com  
www.kvt-fastening.sk

**KVT-Tehnika pritrjevanja d.o.o.**  
Ljubljana | Slovenia  
Tel: +386 1 2808019  
info-SI@kvt-fastening.com  
www.kvt-fastening.si

**KVT-Fastening s.r.o.**  
Brno | Czech Republic  
Tel: +420 547 125200201  
info-CZ@kvt-fastening.com  
www.kvt-fastening.cz

**KVT-Fastening Kft.**  
Budapest | Hungary  
Tel: +36 1 769 0925  
info-HU@kvt-fastening.com  
www.kvt-fastening.hu



[www.kvt-fastening.com](http://www.kvt-fastening.com)

